

# JW24F8/F14

## 3D acceleration sensor

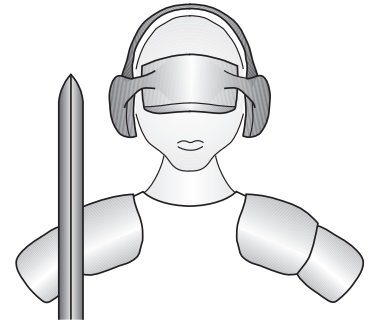

**Code Mercenaries**

### 1. Features

- USB interface (low speed)
- Full USB V1.1/2.0 compliance
- Full USB HID 1.1 compliance
- 3 axis acceleration measurement
- JW24F8: 10 bit resolution for each axis
- JW24F8:  $\pm 2g$ ,  $\pm 4g$ , or  $\pm 8g$  software selectable range
- JW24F14: 14 bit resolution for each axis
- JW24F14:  $\pm 1g$ ,  $\pm 1.5g$ ,  $\pm 2g$ ,  $\pm 3g$ ,  $\pm 4g$ ,  $\pm 8g$ , or  $\pm 16g$  software selectable range
- Data can be read via joystick input or direct
- 8 buttons/aux inputs
- Uses a state of the art compact MEMS sensor
- Sensor settings can be stored in EEPROM
- JW24F8: Computer wake up on acceleration or free fall programmable
- Single +5V power supply
- Available as completely assembled ready to use module or as a USB interface chip in 24 pin SOIC package (not including the sensor element)

#### 1.1 Variants

JoyWarrior24F8/F14 are available as either a completely assembled module including the MEMS sensor, or as just the USB interface chip in SOIC24 package. The interface chip does not include the sensor. The option to buy the interface chip separately is intended for volume production where a tighter integration with the target device is required.

#### 1.2 Custom variants

Custom adaptations are available on request. Customization may be subject to minimum order volumes.

### 2. Functional overview

JoyWarrior24F8/F14 uses a MEMS solid state 3 axis acceleration sensor for acceleration or inclination measurement.

By default the data is reported as joystick data which allows to use JoyWarrior24F8/F14 with existing applications and simplifies implementation for applications where no detailed handling of the sensor parameters is required.

Full access to the sensor data and settings is possible via a generic HID interface (similar to IO-Warrior).

Range, bandwidth, trigger levels, and other parameters can be set permanently in the sensors internal EEPROM. This allows to program the sensor for a specific application and then use the joystick data for easy access.

# JW24F8/F14

### 3.0 Pin configurations

JoyWarrior24F8-S / JoyWarrior24F14-S  
24 Pin SOIC  
Drawing: TOP VIEW!

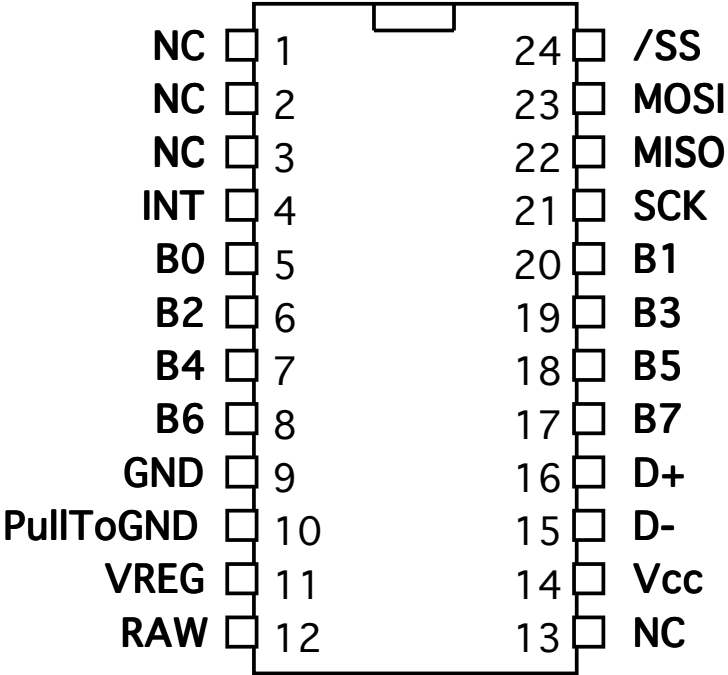

JoyWarrior24F8-MOD / JoyWarrior24F14-MOD  
Module  
Drawing: BOTTOM VIEW! (Components on the other side)

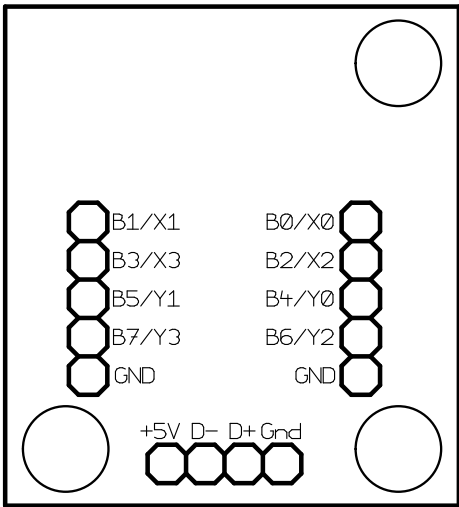

# JW24F8/F14

## 3.1 Axis orientation for JoyWarrior24F8-MOD / JoyWarrior24F14-MOD

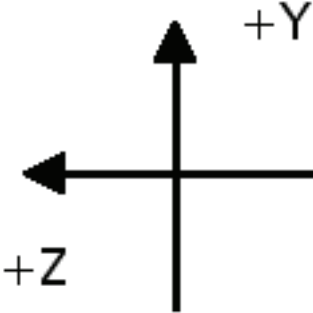
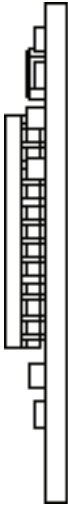
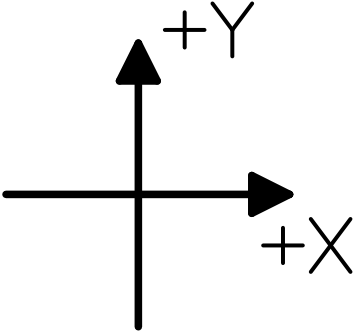
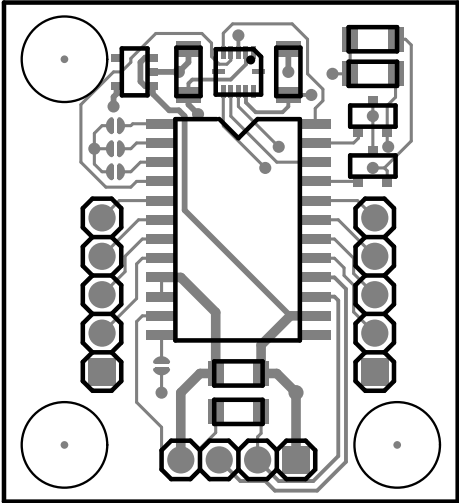

# JW24F8/F14

3.2 Jumper positions for JoyWarrior24F8-MOD / JoyWarrior24F14-MOD

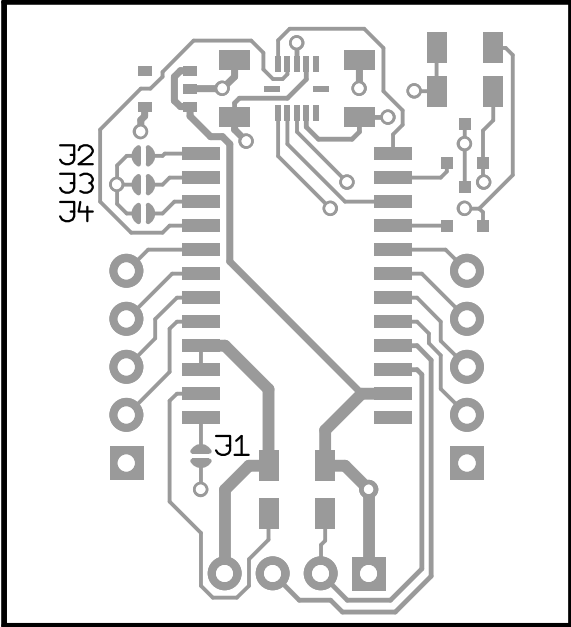

# JW24F8/F14

## 4.0 Pin descriptions JoyWarrior24F8-S / JoyWarrior24F14-S

Name	I/O	Type	Pins	Description
D+, D-	I/O	special	16, 15	USB differential data lines
B0, B1, B2, B3, B4, B5, B6, B7	I	input, internal pull up	5, 20, 6, 19, 7, 18, 8, 17	Button/Aux inputs, active low
INT	I	high impedance	4	INT signal from MEMS sensor
SCK	O	external level shift *	21	SCK to MEMS sensor, level adaption required
MISO	I	high impedance	22	SDO from MEMS sensor
MOSI	O	external level shift *	23	SDI to MEMS sensor, level adaption required
/SS	O	open drain	24	CSB signal to MEMS sensor
RAW	I	internal pull down	12	Pull high for unmapped signed 10 bit data
VREG	O	special **	11	Power for USB D- pull up resistor
PullToGND	I		10	Used during manufacturing, connect to GND
GND		Power supply	9	Ground
Vcc		Power supply	14	Supply voltage
NC			1, 2, 3, 13	do not connect

\*) Level adaption to the 3.3V supply of the MEMS sensor is required.

\*\*) See application circuit for details.

## 4.1 Pin descriptions JoyWarrior24F8-MOD / JoyWarrior24F14-MOD

Name	I/O	Type	Pins	Description
D+, D-	I/O	special		USB differential data lines
B0, B1, B2, B3, B4, B5, B6, B7	I	input, internal pull up		Button/Aux inputs, active low
GND		Power supply		Ground
Vcc		Power supply		USB supply voltage

# JW24F8/F14

## 4.2 Pin descriptions: SOIC24 package

### D+, D-

Differential data lines of USB. Connect these signals direct to a USB cable. D- requires a pull up resistor, see application circuit for details.

### B0..B7

Inputs for the buttons or auxiliary inputs. Connect contacts closing to ground or pull low. Internal pull up resistors.

### VREG

Supplies 3.3V for the USB D- pull up resistor. Don't use this pin to supply power to external circuitry, it does only supply sufficient current for the pull up resistor.

### INT

Input for the INT signal from the MEMS sensor. This input is used to trigger a wake up. High impedance input, connect direct to MEMS sensor.

### SCK

SCK output to the MEMS sensor. External level adaption to the 3.3V supply of the sensor is required. See application circuit for details.

### MISO

Data input from the MEMS sensor. High impedance input, connect direct to SDO of the sensor.

### MOSI

Data output to the MEMS sensor. External level adaption to the 3.3V supply of the sensor is required. See application circuit for details.

### /SS

Enable output to the MEMS sensor. Open drain output, connect direct to CSB of the sensor.

### RAW

Option select to switch off the axis mapping to joystick typical orientation and unsigned format. If this pin is pulled high the axis data is output exactly as it comes from the sensor.

### NC

Do not connect, pins may be used in future variants.

### GND

Power supply ground.

### Vcc

Supply voltage.

## 4.3 Pin descriptions: Module

### D+, D-, Vcc, GND

Connect to a USB cable with a type A plug on its other end.

### B0..B7

Inputs for the buttons or auxiliary inputs. Connect contacts closing to ground or pull low. Internal pull up resistors.

## 4.4 Jumper descriptions: Module

J1 - RAW, closing this jumper does activate the RAW mode where unmapped data is reported.

J2, J3, J4 - unused, don't close these jumpers.

# JW24F8/F14

## 5. Device operation

By following the USB HID specifications JoyWarrior chips are able to work with most operating systems without the need to supply special drivers. Any operating system with support for USB HID devices and game controllers will have the necessary drivers already in place.

The three axes of the sensor are reported as joystick axes X, Y, Z with 10 bit resolution on JW24F8 and 14 bit on JW24F14

### 5.1 Axis orientation

In standard operation the sensor data is mapped to match the standard behaviour of joystick axes. The signed 10 or 14 bit data from the sensor is changed to unsigned format with 511 or 8191 being the neutral position (i.e. 0g). The orientation of the sensor Y axis is inverted. This results in a typical axis orientation for joysticks when the module is in a position with the components on top and the sensor facing away from the user.

By pulling the RAW input high the mapping is switched off so the sensor data is reported unprocessed. While this is less useful for joystick operation it may simplify using the data for measurement applications.

#### 5.1.1 Data filtering

JoyWarrior24F14 uses an internal median filter to decimate the raw data stream of the sensor (about 2000 values/s) to the USB report rate (125 reports/s). This also reduces the noise content of the signal. JoyWarrior24F8 does no additional filtering of the sensor data.

### 5.2 Operation with Windows

Any Windows versions 98 and newer and 2000 and newer will work with JoyWarrior. Older versions of Windows do not support USB. The support software is tested with Windows 2000 and newer.

Upon connecting a JoyWarrior based device for the first time you may be asked to perform the standard driver install.

After the driver installation has completed you should be able to see the device in the "Game Controllers" control panel and be able to access it via DirectInput. Also a generic HID device should show up in the device manager.

Do not use the calibration function of Windows, if the calibration function is used the data reported by JoyWarrior24F8/F14 gets modified by Windows.

To get rid of a calibration you have to remove the JoyWarrior24F8/F14 in the device manager, then unplug, replug, and reinstall it.

Preferably you should read data in the uncalibrated format. See the programming examples for details.

### 5.3 Operation with MacOS

On MacOS X access is available via the HIDManager. Older MacOS versions are not tested.

There will be no warnings or dialogs when a properly functioning JoyWarrior based device is connected under MacOS X, it will simply start to work.

### 5.4 Remote wake up

JoyWarrior24F8 does support remote wake up of a sleeping host. The wake up can take place when a button is pressed while the host is sleeping. Wake up can also be triggered by programming the MEMS sensor to generate an interrupt if a certain condition appears. Those conditions can be an acceleration higher than a programmable trigger level or detection of free fall. Remote wake up has to be enabled by the operating system.

### 5.5 Low level sensor access

Reading the sensor data via the joystick interface is convenient for most applications. However in some situations a more detailed control over the sensor may be required, setting the parameters of the sensor is also not possible via the joystick interface.

To directly access all registers of the MEMS sensor JoyWarrior24F8/F14 does have a second interface (an interface is a logical device in a USB device) that identifies as a generic HID class device. Interface 0 is the joystick function that will be controlled by a system driver. Interface 1 identifies as a generic HID function and can be controlled from application level on most operating systems.

For details of the sensor data please refer to the Bosch SMB380 data sheet for JoyWarrior24F8 and to the Bosch BMA180 data sheet for JoyWarrior24F14.

When accessing the sensor directly make sure you have understood the working details of the sensor. There are a couple registers which must not be overwritten, otherwise the calibration of the sensor may be lost permanently.

# JW24F8/F14

Data is sent to the sensor in a report with the following format:

0	1	2	3	4	5	6	7
Flag/Cnt	Dat0	Dat1	Dat2	Dat3	Dat4	Dat5	Dat6

Flag/Cnt - Contains a flag to disable the joystick data polling and a data count:

7 - Disable flag, 1 = disable

6 - unused, zero

5 - unused, zero

4 - unused, zero

3 - unused, zero

2 - data count MSB

1 - data count

0 - data count LSB

Data count may be 0 to 7, denoting the number of bytes to write to the sensor or read from it.

It is recommended to disable the joystick data polling while communicating with the sensor. So the first report before actually starting communication with the sensor should have a \$80 in the first byte and no data.

Since the communication with the sensor works via SPI the same number of bytes as written to the sensor is read from it at the same time. The data read from the sensor is returned in a report with the following format:

0	1	2	3	4	5	6	7
Count	Dat0	Dat1	Dat2	Dat3	Dat4	Dat5	Dat6

Count is the number of bytes read from the sensor, it may range from 0 to 7. Since the first byte written to the sensor is always the register address the first byte read contains random data.

If a pure write transaction to the sensor is done the read data report is also returned, it will contain random data but a correct count.

## 5.6 Calibration

The sensors are factory calibrated for neutral position and range. Due to mechanical tolerances during soldering the MEMS sensor element on the module and mounting the module in the application a recalibration of the neutral position may be necessary.

A calibration tool is provided that allows to calibrate the neutral position. To do the calibration the sensor needs to be in a stable horizontal position, with the components facing upwards. Start the calibration tool and click on "calibrate",

don't move the sensor while the calibration proceeds.

The calibration on JoyWarrior24F8 can offset the center position in increments of 8.5LSB, a finer calibration needs to be done in software. JoyWarrior24F14 allows calibration to within  $\pm 5$ mg of zero.

In addition to the neutral position calibration the gain can also be calibrated, though the calibration tool does not support setting the gain values. It is not recommended to change the gain values unless the process for this type of calibration is properly understood. Once overwritten there is no way to retrieve the original gain settings from the sensor. Writing the gain values can permanently decalibrate your sensor.

## 5.7 Sensor parameters

The sensor programming tool allows to set the relevant sensor parameters which can be used with the JoyWarrior24F8/F14.

Primary parameters are the measurement range and the filter setting.

On the JoyWarrior24F8 high/low g and any motion settings can be used to wake up a sleeping computer on certain acceleration conditions.

When using the sensor programming tool you have the option to write to the working registers or the EEPROM of the sensor. Settings written to the EEPROM will be stored permanently and will be used by the sensor after a power down or reset.

Writing to the working registers should be used to test settings prior to overwriting the factory settings in the EEPROM. Factory settings can not be restored from within the sensor.

It is also possible to store the settings to a file. The settings file may then either be used by the programming tool or by the automated programming tool, which is intended to set multiple sensors to identical parameters.

To use the automatic programming tool you first have to create a settings file with the programming tool. Then start the automatic programming tool and load the settings file. Any JoyWarrior24F8/F14 that gets connected now will automatically get the settings written to its sensor EEPROM.

# JW24F8/F14

## 5.7.1 Measurement range

The JoyWarrior24F8 sensor can measure in a  $\pm 2g$ ,  $\pm 4g$ , or  $\pm 8g$  range. The resolution over the selected range is always 10 bits.

On JoyWarrior24F14 the resolution is always 14 bits and the measurement range can be  $\pm 1g$ ,  $\pm 1.5g$ ,  $\pm 2g$ ,  $\pm 3g$ ,  $\pm 4g$ ,  $\pm 8g$ , or  $\pm 16g$ .

When written to the sensor EEPROM the selected range will automatically be used every time the sensor is powered up.

## 5.7.2 Bandwidth - JoyWarrior24F8

A digital filter is used to reduce the bandwidth of the sensor data. At the hardware level 3000 values per second are generated, the signal is limited to 1.5kHz by a second order analog filter prior to A/D conversion. Downsampling of the digital signal can be set to a bandwidth of 25, 50, 100, 190, 375, 750, or 1500Hz.

Since a maximum of 125 values per second are read any bandwidth higher than 100Hz does not result in a higher timing resolution. Additionally it should be kept in mind that with rising bandwidth the noise level is also rising. Noise is  $0.5mg \cdot \sqrt{f}$ , so at 50Hz you can expect about 1LSB noise.

## 5.7.3 LG / HG / Any Motion - JoyWarrior24F8

If any of the LG, HG, or Any Motion options is enabled the JW24F8 can wake a sleeping host computer if a LG (i.e. free fall) or HG situation is detected or if any motion happens above a selected threshold. Please refer to the SMB380 data sheet for details of these functions.

Only the options useable in the JW24F8 setup are supported by the programming tool. The sensor element does support more features but those make sense only in a different hardware setup.

## 5.7.4 Bandwidth - JoyWarrior24F14

The sensor element of JoyWarrior24F14 has an internal filter to reduce the signal bandwidth. The filter can be set to work as a low pass with cut off at 10, 20, 40, 75, 150, 300, 600, or 1200Hz. Additionally a high pass filter with 1Hz cut off and a band pass for 0.2Hz to 300Hz are available.

Since the data rate is limited to 125 reports per second it does not make sense to use low pass filter settings above 75Hz.

Use of the lowest possible bandwidth for the chosen application is recommended to reduce the noise level.

# JW24F8/F14

## 6. DC Characteristics JW24F8-S / JW24F8-MOD / JW24F14-S / JW24F14-MOD

	Parameter	Min	Max	Units	Remarks
V <sub>cc</sub>	Operating voltage	4.35	5.25	V	
I <sub>cc</sub>	Operating supply current		20	mA	
I <sub>sb</sub>	Suspend mode current (chip)		25	μA	Oscillator off
I <sub>sb</sub>	Suspend mode current (module)		350	μA	Sensor working
R <sub>up</sub>	Pull-up resistance	8	24	kΩ	
V <sub>ith</sub>	Input threshold voltage	40%	60%	V <sub>cc</sub>	
	<b>USB Interface</b>				
V <sub>oh</sub>	Static output high	2.8	3.6	V	15kΩ±5% to GND
V <sub>ol</sub>	Static output low		0.3	V	
V <sub>di</sub>	Differential input sensitivity	0.2		V	$(D+) - (D-)$
V <sub>cm</sub>	Differential input common mode range	0.8	2.5	V	
V <sub>se</sub>	Single ended transceiver threshold	0.8	2.0	V	
C <sub>in</sub>	Transceiver capacitance		20	pF	
I <sub>io</sub>	Hi-Z State data line leakage	-10	10	μA	0V < V <sub>in</sub> < 3.3V, Hi-Z State
R <sub>pu</sub>	Bus pull-up resistance	1.274	1.326	kΩ	1.3kΩ±2% to V <sub>reg</sub>
R <sub>pd</sub>	Bus pull-down resistance	14.25	15.75	kΩ	15kΩ±5%

## 6.1 AC Characteristics JW24F8-S / JW24F8-MOD / JW24F14-S / JW24F14-MOD

	Parameter	Min	Max	Units	Remarks
F <sub>iclk2</sub>	Internal clock frequency	5.91	6.09	MHz	Clock synchronized to USB
	<b>USB Driver Characteristics</b>				
t <sub>r</sub>	Transition rise time	75		ns	C <sub>Load</sub> = 50pF
t <sub>r</sub>	Transition rise time		300	ns	C <sub>Load</sub> = 350pF
t <sub>f</sub>	Transition fall time	75		ns	C <sub>Load</sub> = 50pF
t <sub>f</sub>	Transition fall time		300	ns	C <sub>Load</sub> = 350pF
t <sub>rfm</sub>	Rise/Fall time matching	80	125	%	
V <sub>crs</sub>	Output signal crossover voltage	1.3	2.0	V	
	<b>USB Data Timing</b>				
t <sub>drate</sub>	Low speed data rate	1.4775	1.5225	MBit/s	
t <sub>djr1</sub>	Receiver data jitter tolerance	-75	75	ns	To next transition
t <sub>djr2</sub>	Receiver data jitter tolerance	-45	45	ns	For paired transitions
t <sub>deop</sub>	Differential to EOP transition skew	-40	100	ns	
t <sub>eopr1</sub>	EOP width at receiver	165		ns	Rejects as EOP
t <sub>eopr2</sub>	EOP width at receiver	675		ns	Accepts as EOP
t <sub>eopt</sub>	Source EOP width	1.25	1.50	μs	
t <sub>udj1</sub>	Differential driver jitter	-95	95	ns	To next transition
t <sub>udj2</sub>	Differential driver jitter	-150	150	ns	To paired transition

# JW24F8/F14

## 6.2 Absolute maximum ratings

Storage Temperature	-50°C to +150°C
Ambient Operating Temperature	0°C to +70°C
Supply Voltage on VCC relative to VSS	-0.5V to +7.0V
DC Input Voltage	-0.5V to VCC + 0.5V
Max. Output Current into any Pin	60mA
Power Dissipation	300mW
Static Discharge Voltage (USB and button inputs)	>2000V
Latch-up Current	>200mA
EEPROM write cycles (same byte)	≥1000
EEPROM data retention (at 55°C after 1000 cycles)	≥10 years
Mechanical Shock *	10,000g, ≤100μs 2,000g, ≤1ms ≤1.5m

Free fall onto hard surface \*

\*) Maximum shock specs apply for the sensor element only. Using the module in high g environments will require additional mechanical protection.

## 6.3 Sensor characteristics (JW24F8-MOD)

	Parameter	Min	Typ	Max	Units
S <sub>2g</sub>	Acceleration resolution at ±2g	246	256	266	LSB/g
S <sub>4g</sub>	Acceleration resolution at ±4g	122	128	134	LSB/g
S <sub>8g</sub>	Acceleration resolution at ±8g	61	64	67	LSB/g
Off	Zero-g offset at T <sub>A</sub> = 25°C	-60		60	mg
Off	Zero-g offset over lifetime, T <sub>A</sub> = 25°C	-150		150	mg
	Zero-g offset temperature drift		1		mg/K
NL	Nonlinearity	-0.5%		0.5%	%FS
n <sub>rms</sub>	Output noise		0.5		mg*√f (filter bandwidth)
/S	Cross axis sensitivity, relative between axes			2	%

## 6.4 Sensor characteristics (JW24F14-MOD)

	Parameter	Min	Typ	Max	Units
S <sub>1g</sub>	Acceleration resolution at ±1g		8192 ±2%		LSB/g
S <sub>1.5g</sub>	Acceleration resolution at ±1.5g		5460 ±2%		LSB/g
S <sub>2g</sub>	Acceleration resolution at ±2g		4096 ±1.5%		LSB/g
S <sub>3g</sub>	Acceleration resolution at ±3g		2730 ±2%		LSB/g
S <sub>4g</sub>	Acceleration resolution at ±4g		2048 ±2%		LSB/g
S <sub>8g</sub>	Acceleration resolution at ±8g		1024 ±2.5%		LSB/g
S <sub>16g</sub>	Acceleration resolution at ±16g		512 ±3%		LSB/g
TCS	Temperature Coefficient of Sensitivity		±0.01		%/K
Off	Zero-g Offset at T <sub>A</sub> = 25°C	-15		15	mg
Off	Zero-g Offset over lifetime, T <sub>A</sub> = 25°C	-35		35	mg
	Zero-g Offset temperature drift		±0.25		mg/K
NL	Nonlinearity 1g, 1.5g, 2g	-0.10%		0.10%	%FS
NL	Nonlinearity 3g, 4g	-0.25%		0.25%	%FS
NL	Nonlinearity 8g, 16g	-0.75%		0.75%	%FS
n <sub>rms</sub>	Output Noise (2g, 10Hz)		150		μg*√f (filter bandwidth)
/S	Cross Axis Sensitivity, relative between axes		0.1		%

# JW24F8/F14

## 7. Ordering information

Partname	Order Code	Description	Package
JoyWarrior24F8 Module	JW24F8-MOD	3D acceleration sensor complete module	Module
JoyWarrior24F8	JW24F8-S	3D acceleration sensor interface chip	SOIC24
JoyWarrior24F14 Module	JW24F14-MOD	3D acceleration sensor complete module	Module
JoyWarrior24F14	JW24F14-S	3D acceleration sensor interface chip	SOIC24

The chips listed here are standard products. Customized chips are available on request.

### 7.1 Packaging info

SOIC24 chips come in tubes with 31 chips each. To assure best handling and shipping safety please order the chips in full tubes. Custom chips are produced in multiples of full tubes only. JW24F8/F14-MOD modules come in antistatic boxes or antistatic bags packaged single or bulk.

### 7.2 USB VendorID and ProductID

By default all JoyWarrior chips are shipped with the USB VendorID of Code Mercenaries (\$7C0 or decimal 1984) and a fixed ProductID.

On request chips can be equipped with the customers VendorID and ProductID. VendorIDs can be obtained from the USB Implementers Forum <[www.usb.org](http://www.usb.org)>.

Customized chips are subject to minimum order quantities, contact <[sales@codemerces.com](mailto:sales@codemerces.com)> for details.

Following are the ProductIDs for the JoyWarrior controllers:

JoyWarrior24F8	\$1113
JoyWarrior24F14	\$1116

ProductIDs are independent of the package type.

See the JoyWarrior data sheet for version information.

### 7.3 Serial numbers

The JoyWarrior24F8/F14 has an unique serial number in its device descriptor. These serial numbers can be used to simplify programming for multiple JoyWarriors connected to a single computer.

The serial numbers are factory programmed and can not be changed. Serial numbers are 8 digit hexadecimal numbers. No two chips of a type will be produced with identical serial numbers.

It is not possible to order chips with a specific serial number unless they are ordered as custom chips which are subject to minimum order volumes and setup charges.

# JW24F8/F14

## 8. Typical application for JoyWarrior24F8/F14 (as used on the module)

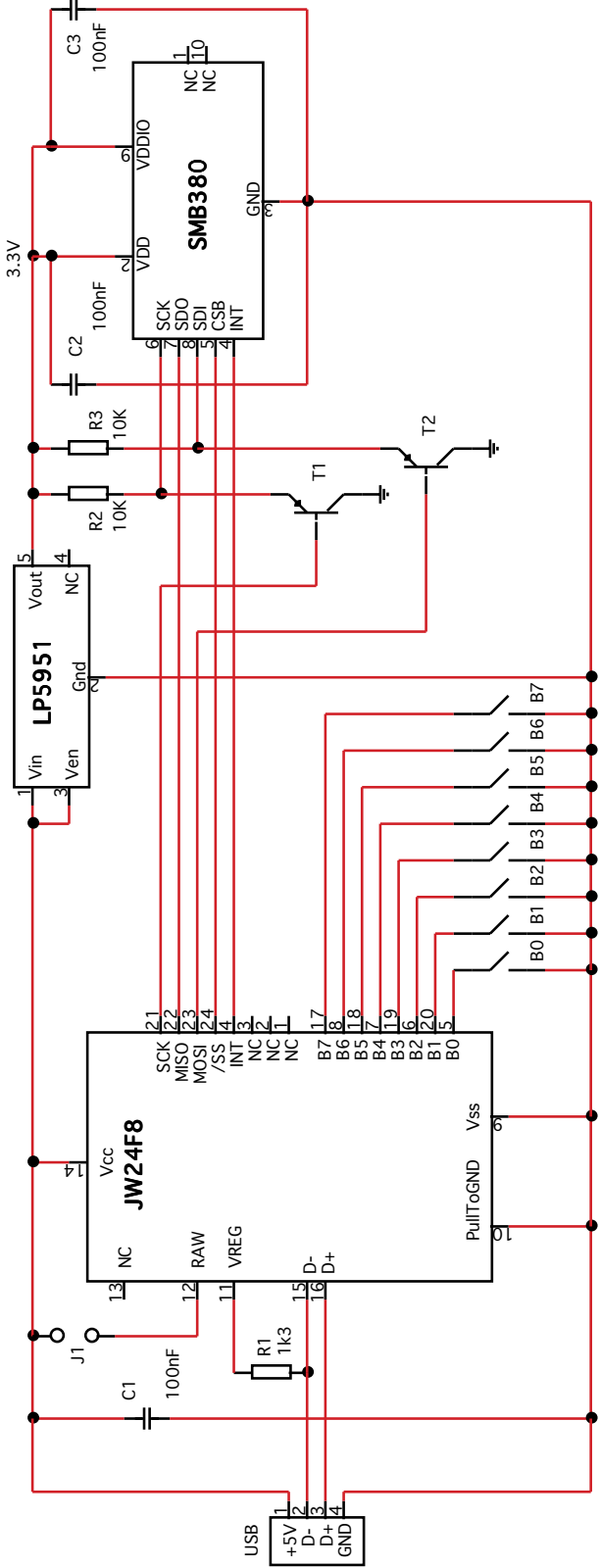

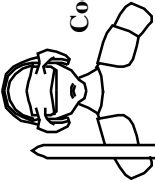
 <p>Code Mercenaries</p>				
<b>Circuit:</b>	JoyWarrior 24F8			
<b>Version:</b>	V1.0			
<b>Date:</b>	19.10.2007			
<b>Drawn by:</b>				
<b>Function:</b>				
<b>Page:</b>				
<b>Rev.</b>	<b>Date</b>	<b>By</b>	<b>Change</b>	<b>Sign.</b>

# JW24F8/F14

## 9. Package dimensions

### 24 Pin SOIC

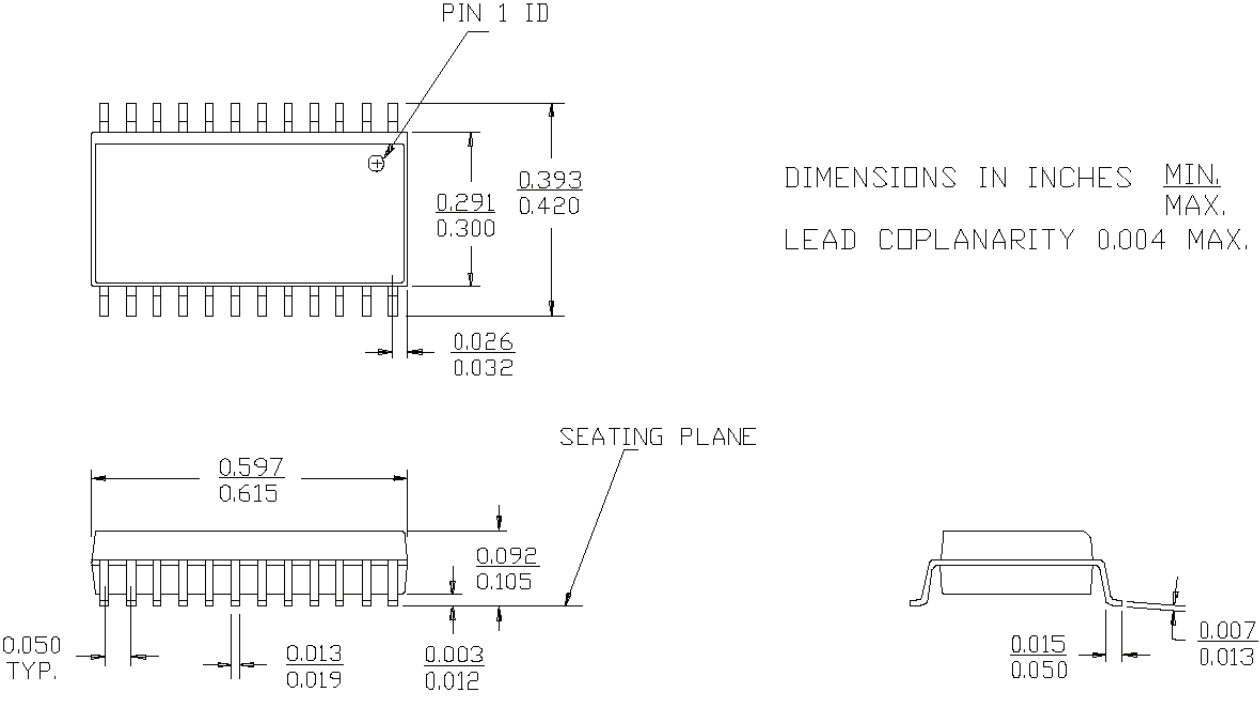

### Module

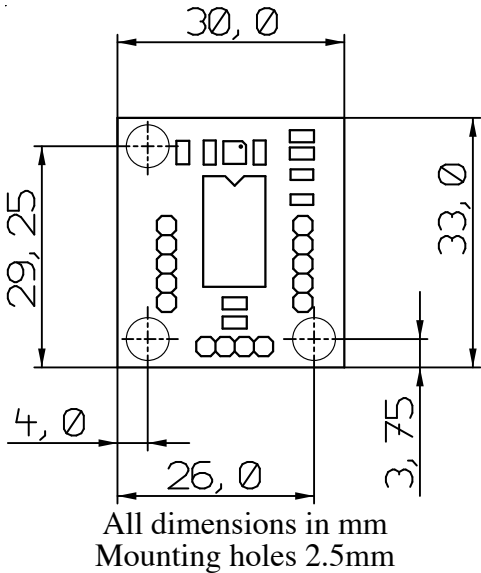

# JW24F8/F14

## 10. ESD Considerations

JoyWarrior has an internal ESD protection to withstand discharges of more than 2000V without permanent damage. However ESD may disrupt normal operation of the chip and cause it to exhibit erratic behaviour.

For the typical office environment the 2000V protection is normally sufficient. Though for industrial use additional measures may be necessary.

When adding ESD protection to the signals special care must be taken on the USB signal lines. The USB has very low tolerance for additional resistance or capacitance introduced on the USB differential signals.

Series resistors of  $27\Omega$  may be used alone or in addition to some kind of suppressor device. In any case the USB 2.0 specification chapter 6 and 7 should be read for detailed specification of the electrical properties.

### 10.1 EMC considerations

JoyWarrior uses relatively low power levels and so it causes few EMC problems.

To avoid any EMC problems the following rules should followed:

- Put the 100nF ceramic capacitor right next to the power supply pins of the chip and make sure the PCB traces between the chips power pins and the capacitor are as short as possible.
- Run the power supply lines first to the capacitor, then to the chip.
- Keep the two USB signal lines close to each other, route no other signal between them. USB uses differential signalling so the best signal quality with lowest RF emission is achieved by putting these lines very close to each other.
- Adding a ferrite bead to the +5V power supply line is advisable.

## 11. Revision history

Please refer to the JoyWarrior main data sheet for the revision history.

Current shipping version of JW24F8 is V1.0.3.8

Initial shipping version of JW24F14 is V1.0.4.0

## Legal stuff

This document is ©1999-2010 by Code Mercenaries GmbH.

The information contained herein is subject to change without notice. Code Mercenaries makes no claims as to the completeness or correctness of the information contained in this document.

Code Mercenaries assumes no responsibility for the use of any circuitry other than circuitry embodied in a Code Mercenaries product. Nor does it convey or imply any license under patent or other rights.

Code Mercenaries products may not be used in any medical apparatus or other technical products that are critical for the functioning of lifesaving or supporting systems. We define these systems as such that in the case of failure may lead to the death or injury of a person. Incorporation in such a system requires the explicit written permission of the president of Code Mercenaries.

Trademarks used in this document are properties of their respective owners.

Code Mercenaries  
Hard- und Software GmbH  
Karl-Marx-Str. 147a  
12529 Schönefeld  
Germany  
Tel: x49-3379-20509-20  
Fax: x49-33790-20509-30  
Mail: support@codemerics.com  
Web: www.codemerics.com

HRB 16007 P  
Geschäftsführer: Guido Körber, Christian Lucht